

# ES4600-K4-T1 Exit Alarm Configuration

## Specifications: ES4600

- Power: 12-24 VAC/VDC at 500mA
- Output Relays: N/C & N/O contact 1000mA at 30 VDC
- Remote Speaker: 3 Watts 8 Ohms
- Warning message: "Please close the door"
- Alarm message: "Security violation, close the door"

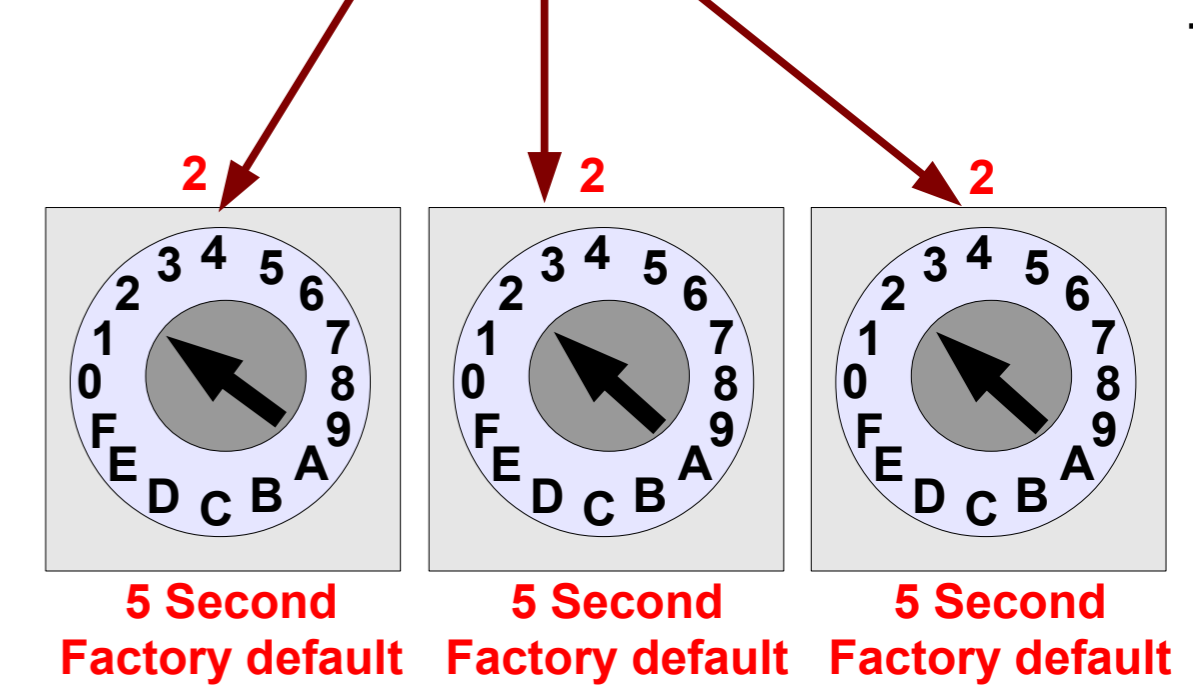
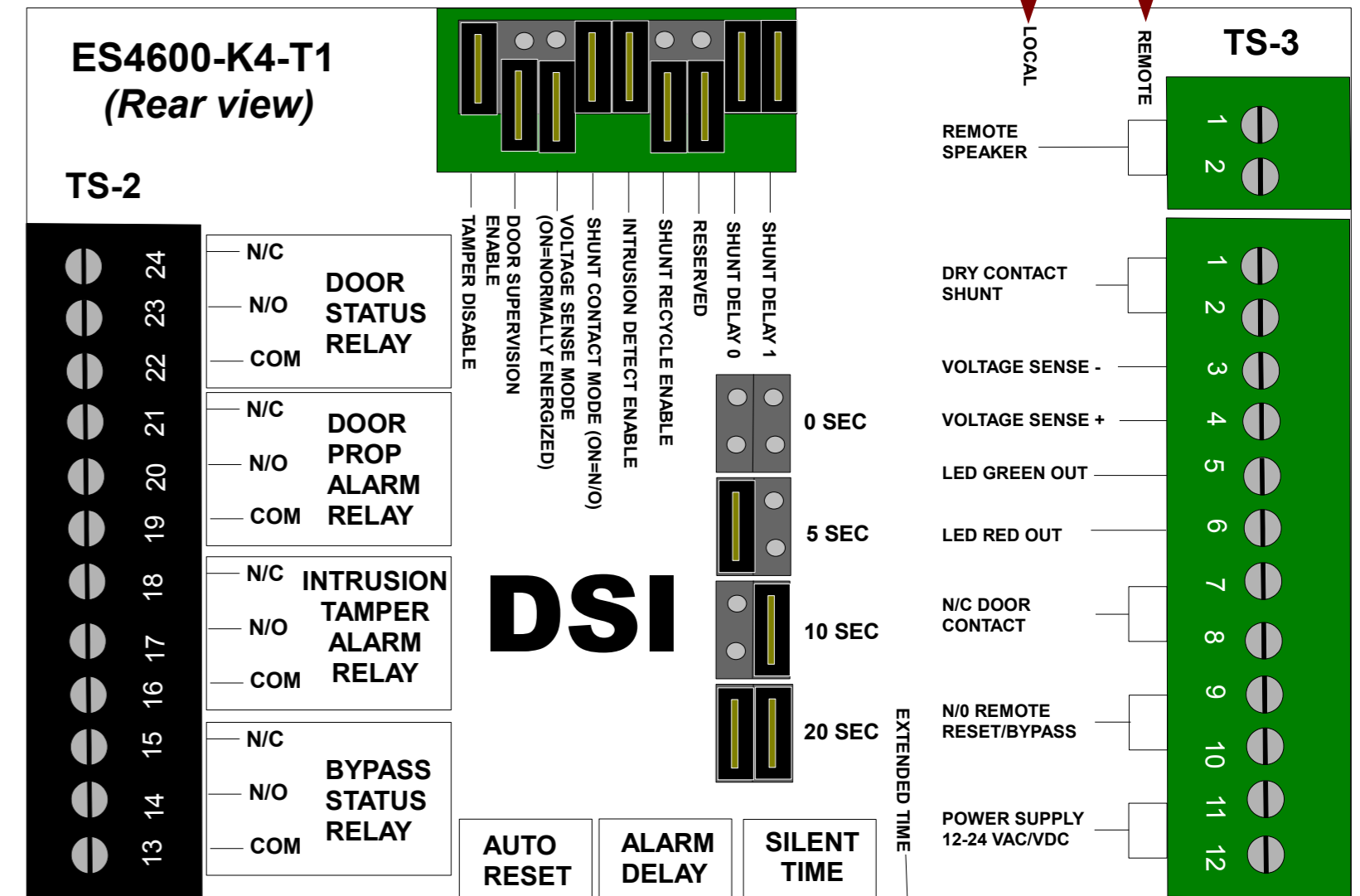
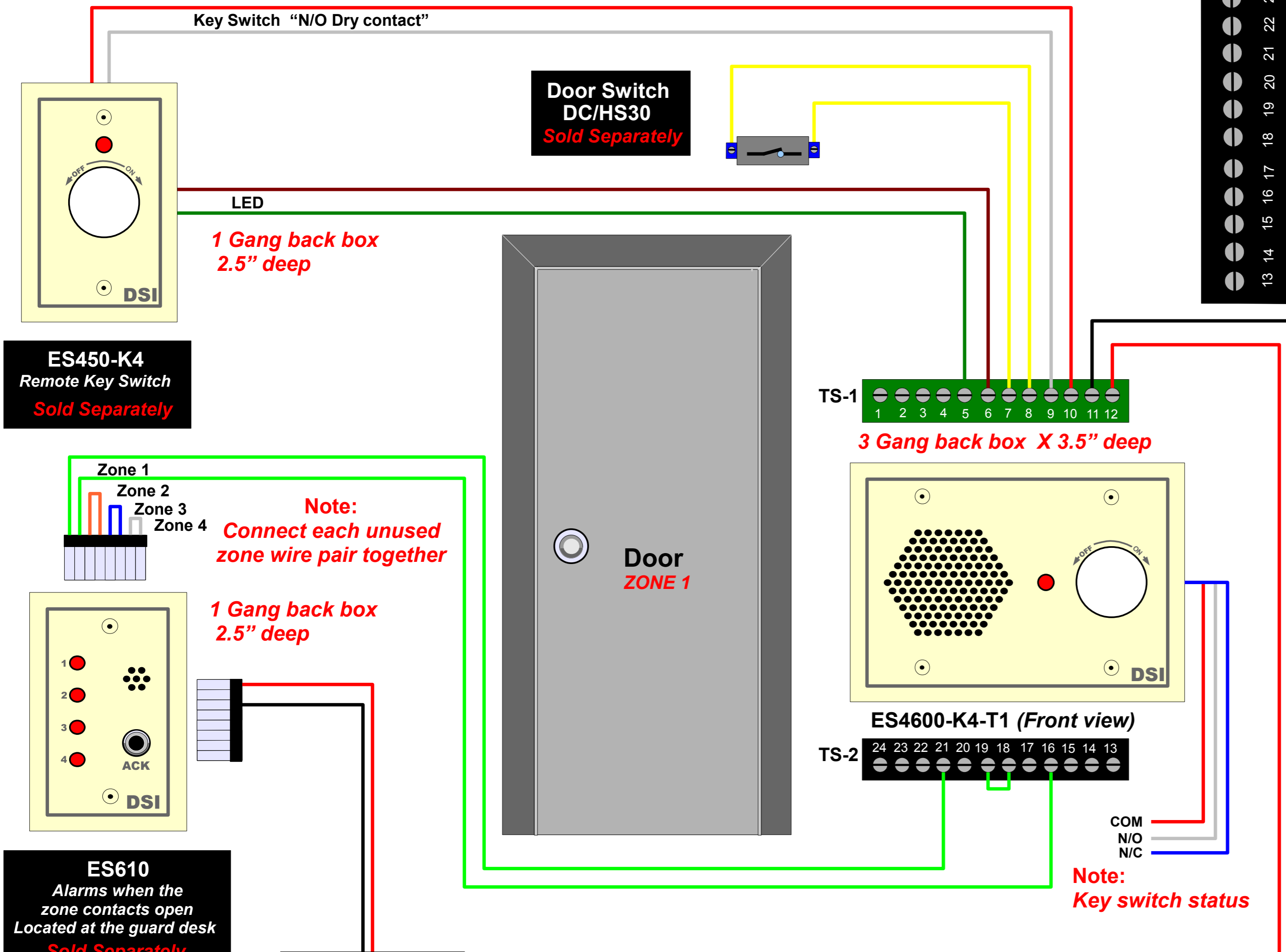

SET	Auto Reset	Alarm Delay	Silent Time	
			Normal	Extended
0	0 Sec	0 Sec	0 Sec	3 Min
1	3 Sec	3 Sec	3 Sec	3.5 Min
2	5 Sec	5 Sec	5 Sec	4 Min
3	7 Sec	7 Sec	7 Sec	4.5 Min
4	10 Sec	10 Sec	10 Sec	5 Min
5	12 Sec	12 Sec	12 Sec	6 Min
6	15 Sec	15 Sec	15 Sec	7 Min
7	20 Sec	20 Sec	20 Sec	8 Min
8	30 Sec	30 Sec	25 Sec	9 Min
9	45 Sec	45 Sec	30 Sec	10 Min
A	1 Min	1 Min	35 Sec	20 Min
B	2 Min	2 Min	45 Sec	30 Min
C	3 Min	3 Min	1 Min	40 Min
D	4 Min	4 Min	1.5 Min	50 Min
E	5 Min	5 Min	2 Min	60 Min
F	Manual	Infinite	2.5 Min	90 Min

**Note:** Wire Gauge:  
 22 AWG = Signal wires  
 22 AWG = Power wires  
 (Power runs over 50 feet use 18 AWG)

**Note:** Suggested Power Supply  
 PS/DC12  
 PS/AC16

12-24 VAC/VDC  
 500mA  
 Power Supply  
 Sold Separately

# ES4600-K4-T1 Exit Alarm Configuration

## Supervised Door

Specifications: ES4600

Power: 12-24 VAC/VDC at 500mA

Output Relays: N/C & N/O contact 1000mA at 30 VDC

Remote Speaker: 3 Watts 8 Ohms

Warning message: "Please close the door"

Alarm message: "Security violation, close the door"

Supervision Enable  
Jumper placement  
Use 1K OHM resistors  
on door switch

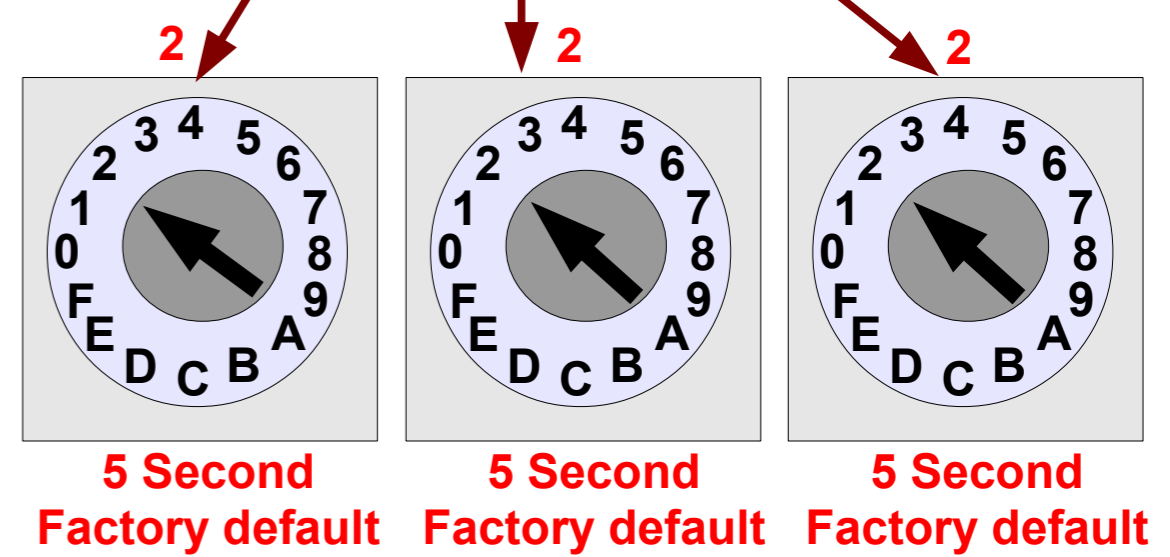
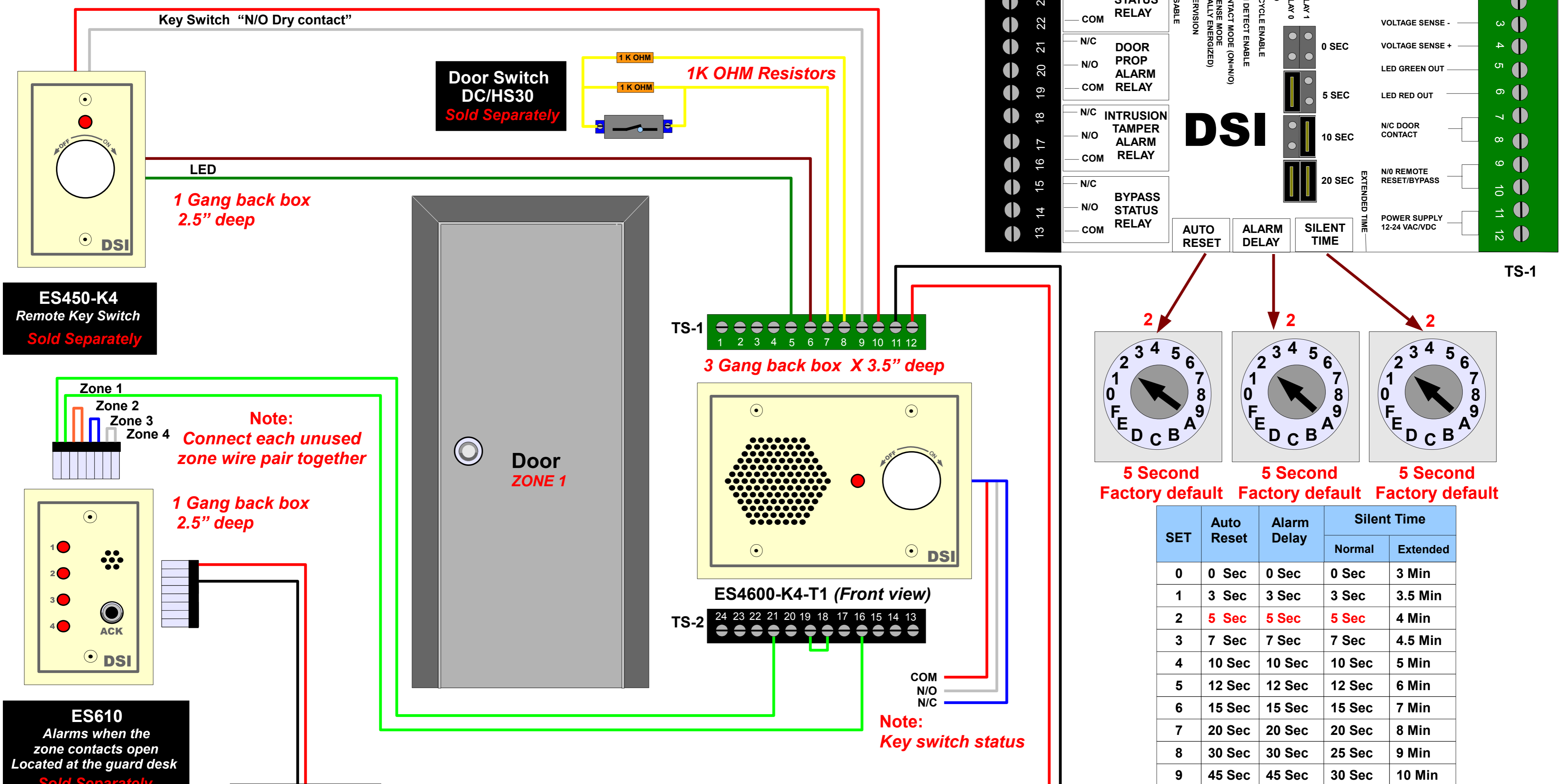

SET	Auto Reset	Alarm Delay	Silent Time	
			Normal	Extended
0	0 Sec	0 Sec	0 Sec	3 Min
1	3 Sec	3 Sec	3 Sec	3.5 Min
2	5 Sec	5 Sec	5 Sec	4 Min
3	7 Sec	7 Sec	7 Sec	4.5 Min
4	10 Sec	10 Sec	10 Sec	5 Min
5	12 Sec	12 Sec	12 Sec	6 Min
6	15 Sec	15 Sec	15 Sec	7 Min
7	20 Sec	20 Sec	20 Sec	8 Min
8	30 Sec	30 Sec	25 Sec	9 Min
9	45 Sec	45 Sec	30 Sec	10 Min
A	1 Min	1 Min	35 Sec	20 Min
B	2 Min	2 Min	45 Sec	30 Min
C	3 Min	3 Min	1 Min	40 Min
D	4 Min	4 Min	1.5 Min	50 Min
E	5 Min	5 Min	2 Min	60 Min
F	Manual	Infinite	2.5 Min	90 Min

Note: Wire Gauge:  
22 AWG = Signal wires  
22 AWG = Power wires  
(Power runs over 50 feet use 18 AWG)

Note: Suggested Power Supply  
PS/DC12  
PS/AC16

# ES4600-K4-T1 Door Prop Configuration

## Specifications: ES4600

- Power: **12-24 VAC/VDC at 500mA**
- Output Relays: **N/C & N/O contact 1000mA at 30 VDC**
- Remote Speaker: **3 Watts 8 Ohms**
- Warning message: **"Please close the door"**
- Alarm message: **"Security violation, close the door"**

Intrusion Detect Enable Jumper placement

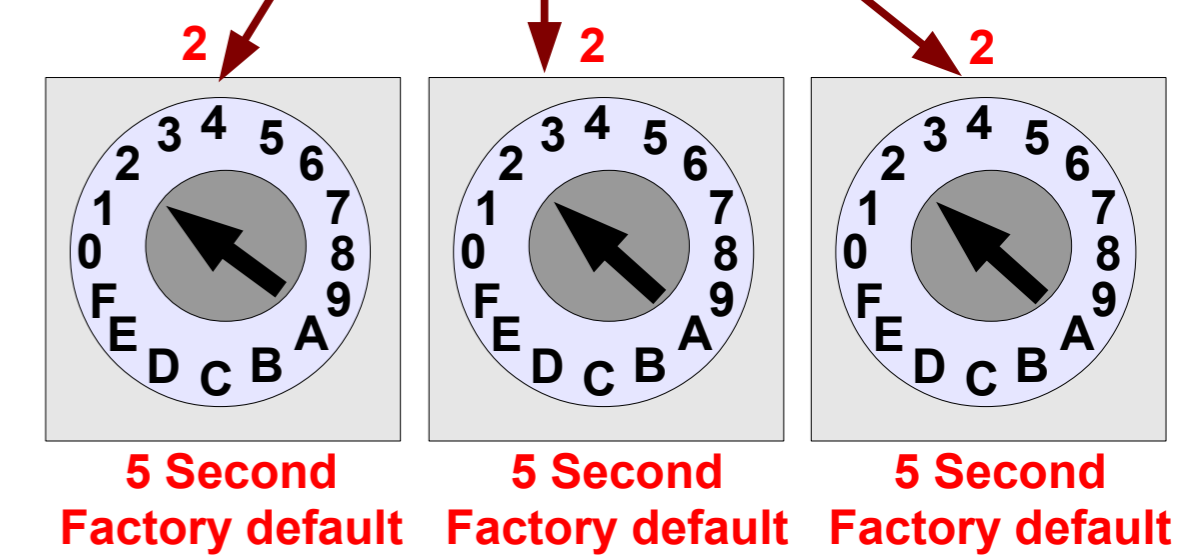
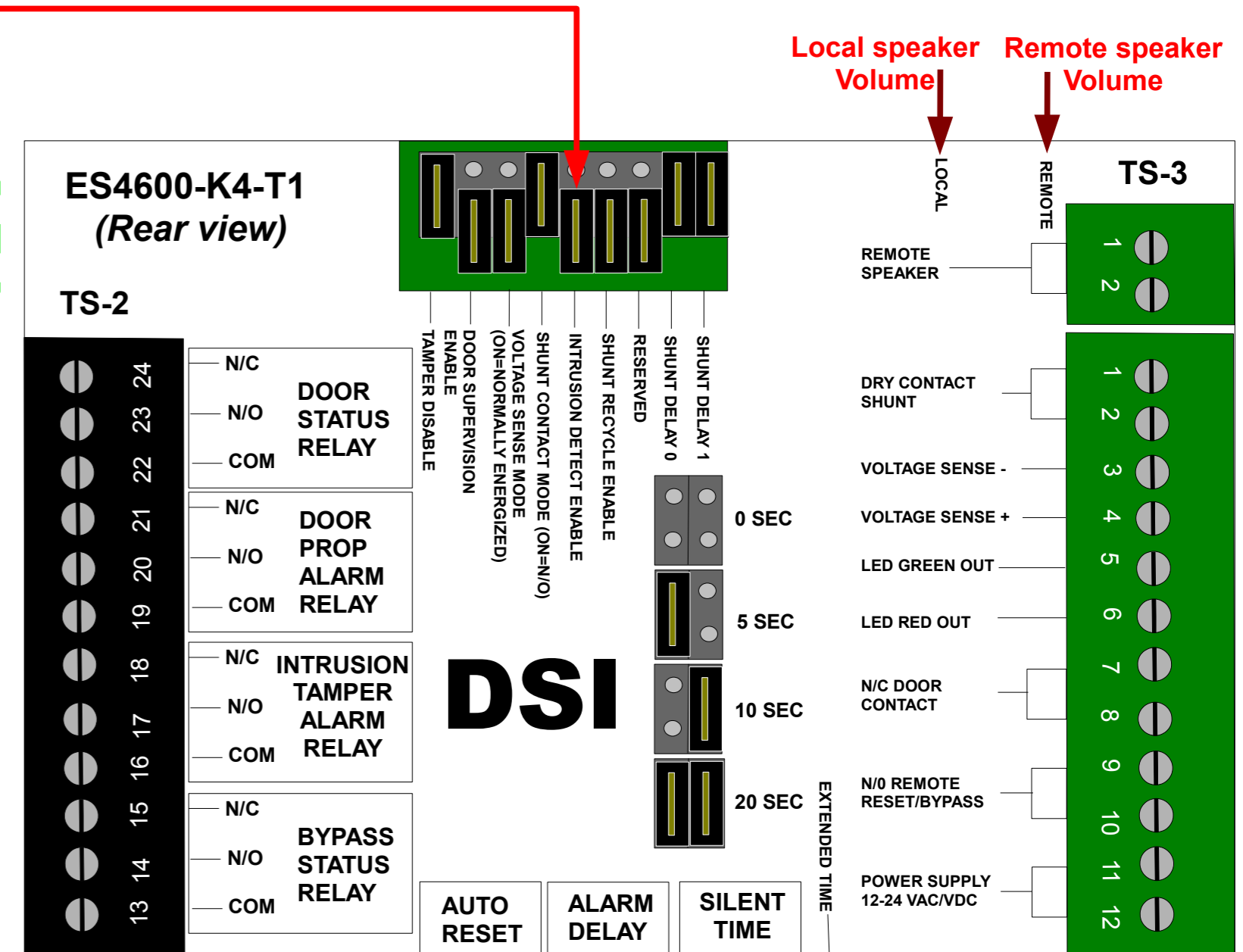
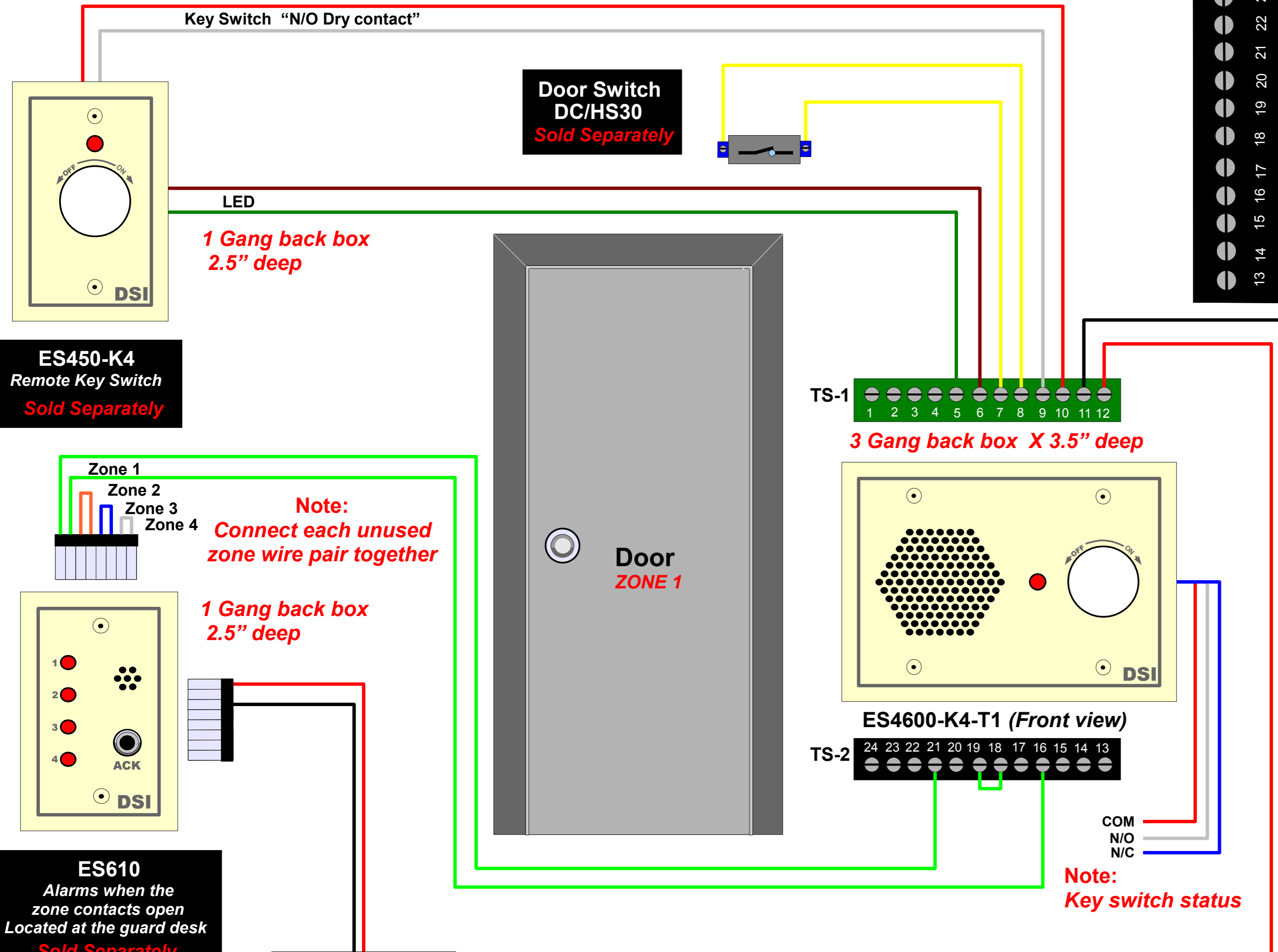

SET	Auto Reset	Alarm Delay	Silent Time	
			Normal	Extended
0	0 Sec	0 Sec	0 Sec	3 Min
1	3 Sec	3 Sec	3 Sec	3.5 Min
2	5 Sec	5 Sec	5 Sec	4 Min
3	7 Sec	7 Sec	7 Sec	4.5 Min
4	10 Sec	10 Sec	10 Sec	5 Min
5	12 Sec	12 Sec	12 Sec	6 Min
6	15 Sec	15 Sec	15 Sec	7 Min
7	20 Sec	20 Sec	20 Sec	8 Min
8	30 Sec	30 Sec	25 Sec	9 Min
9	45 Sec	45 Sec	30 Sec	10 Min
A	1 Min	1 Min	35 Sec	20 Min
B	2 Min	2 Min	45 Sec	30 Min
C	3 Min	3 Min	1 Min	40 Min
D	4 Min	4 Min	1.5 Min	50 Min
E	5 Min	5 Min	2 Min	60 Min
F	Manual	Infinite	2.5 Min	90 Min

Note: Wire Gauge:  
 22 AWG = Signal wires  
 22 AWG = Power wires  
 (Power runs over 50 feet use 18 AWG)

Note: Suggested Power Supply  
 PS/DC12  
 PS/AC16

12-24 VAC/VDC 500mA Power Supply Sold Separately

# ES4600-K4-T1 Magnetic Lock Configuration

## Push Button REX

### Specifications: ES4600

Power: 12-24 VAC/VDC at 500mA

Output Relays: N/C & N/O contact 1000mA at 30 VDC

Remote Speaker: 3 Watts 8 Ohms

Warning message: "Please close the door"

Alarm message: "Security violation, close the door"

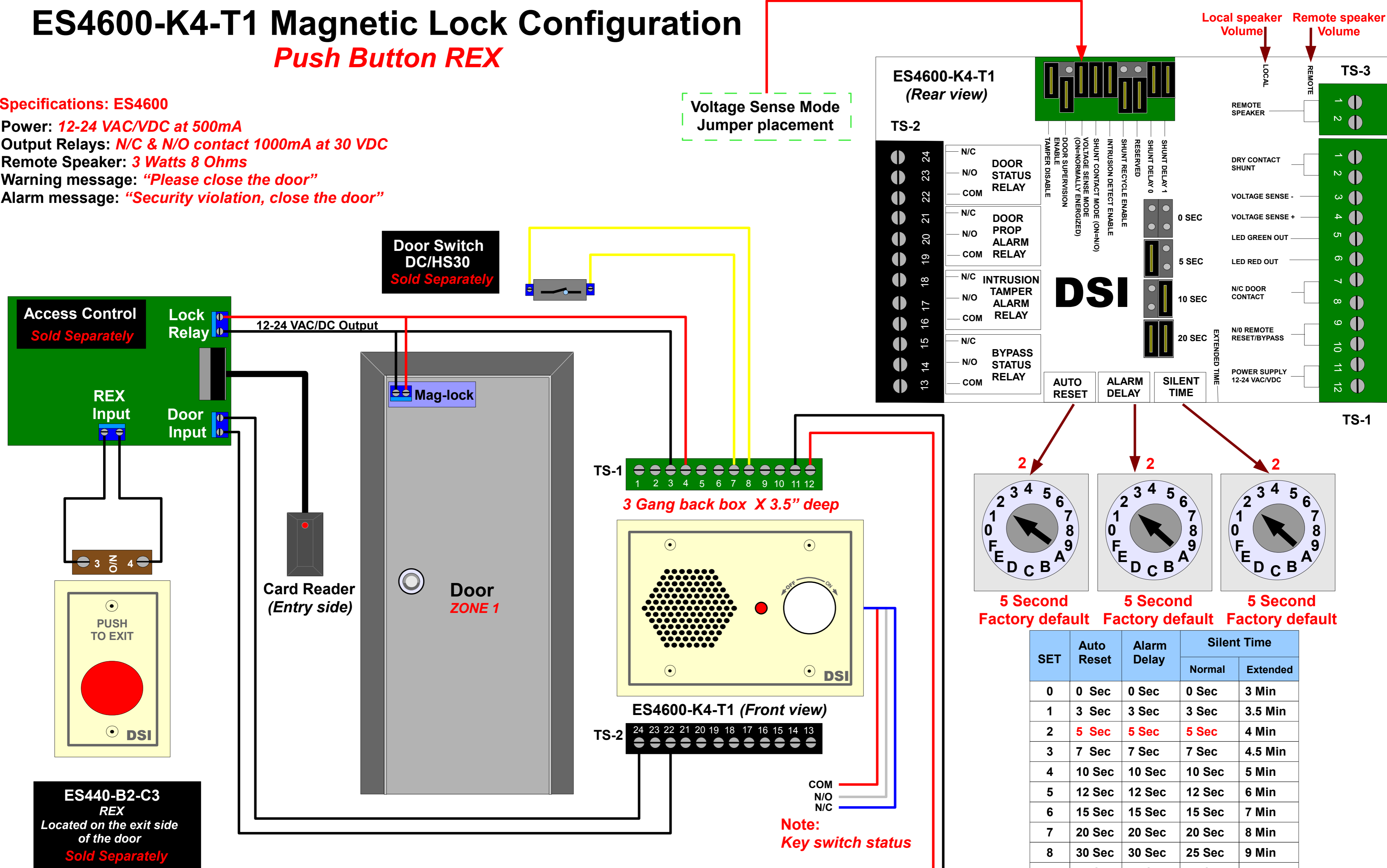

Voltage Sense Mode Jumper placement

TS-1  
1 2 3 4 5 6 7 8 9 10 11 12  
3 Gang back box X 3.5" deep

ES4600-K4-T1 (Front view)  
TS-2  
24 23 22 21 20 19 18 17 16 15 14 13

ES4600-K4-T1 (Rear view)

TS-2  
13 14 15 16 17 18 19 20 21 22 23 24  
N/C DOOR STATUS RELAY  
N/O DOOR PROP ALARM RELAY  
COM  
N/C DOOR PROP ALARM RELAY  
N/O INTRUSION TAMPER ALARM RELAY  
COM  
N/C BYPASS STATUS RELAY  
N/O  
COM

ES4600-K4-T1 (Rear view) - Terminal Block TS-3  
LOCAL (Remote Speaker Volume)  
REMOTE (Remote Speaker Volume)  
1 2  
REMOTE SPEAKER  
1 2  
DRY CONTACT SHUNT  
VOLTAGE SENSE -  
VOLTAGE SENSE +  
LED GREEN OUT  
LED RED OUT  
N/C DOOR CONTACT  
N/O REMOTE RESET/BYPASS  
POWER SUPPLY 12-24 VAC/VDC  
1 2 3 4 5 6 7 8 9 10 11 12

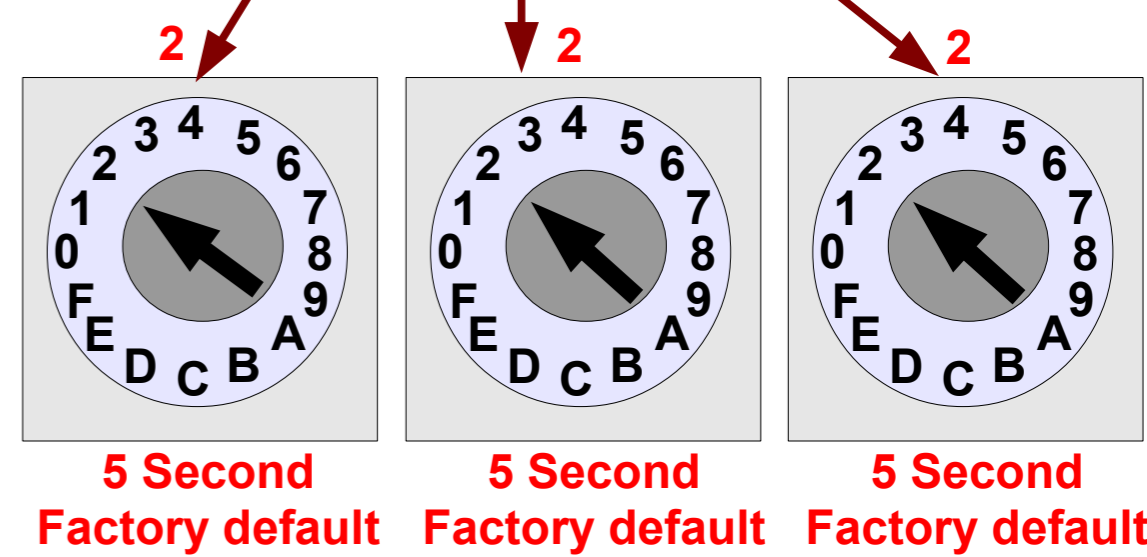

SET	Auto Reset	Alarm Delay	Silent Time	
			Normal	Extended
0	0 Sec	0 Sec	0 Sec	3 Min
1	3 Sec	3 Sec	3 Sec	3.5 Min
2	5 Sec	5 Sec	5 Sec	4 Min
3	7 Sec	7 Sec	7 Sec	4.5 Min
4	10 Sec	10 Sec	10 Sec	5 Min
5	12 Sec	12 Sec	12 Sec	6 Min
6	15 Sec	15 Sec	15 Sec	7 Min
7	20 Sec	20 Sec	20 Sec	8 Min
8	30 Sec	30 Sec	25 Sec	9 Min
9	45 Sec	45 Sec	30 Sec	10 Min
A	1 Min	1 Min	35 Sec	20 Min
B	2 Min	2 Min	45 Sec	30 Min
C	3 Min	3 Min	1 Min	40 Min
D	4 Min	4 Min	1.5 Min	50 Min
E	5 Min	5 Min	2 Min	60 Min
F	Manual	Infinite	2.5 Min	90 Min

Note: Key switch status

12-24 VAC/VDC 500mA Power Supply Sold Separately

Note: Wire Gauge:  
22 AWG = Signal wires  
22 AWG = Power wires  
(Power runs over 50 feet use 18 AWG)

Note: Suggested Power Supply  
PS/DC12  
PS/AC16

ES440-B2-C3 REX  
Located on the exit side of the door  
Sold Separately

Door Switch DC/HS30  
Sold Separately

# ES4600-K4-T1 Door Strike Configuration

## Push Button REX

### Specifications: ES4600

Power: 12-24 VAC/VDC at 500mA

Output Relays: N/C & N/O contact 1000mA at 30 VDC

Remote Speaker: 3 Watts 8 Ohms

Warning message: "Please close the door"

Alarm message: "Security violation, close the door"

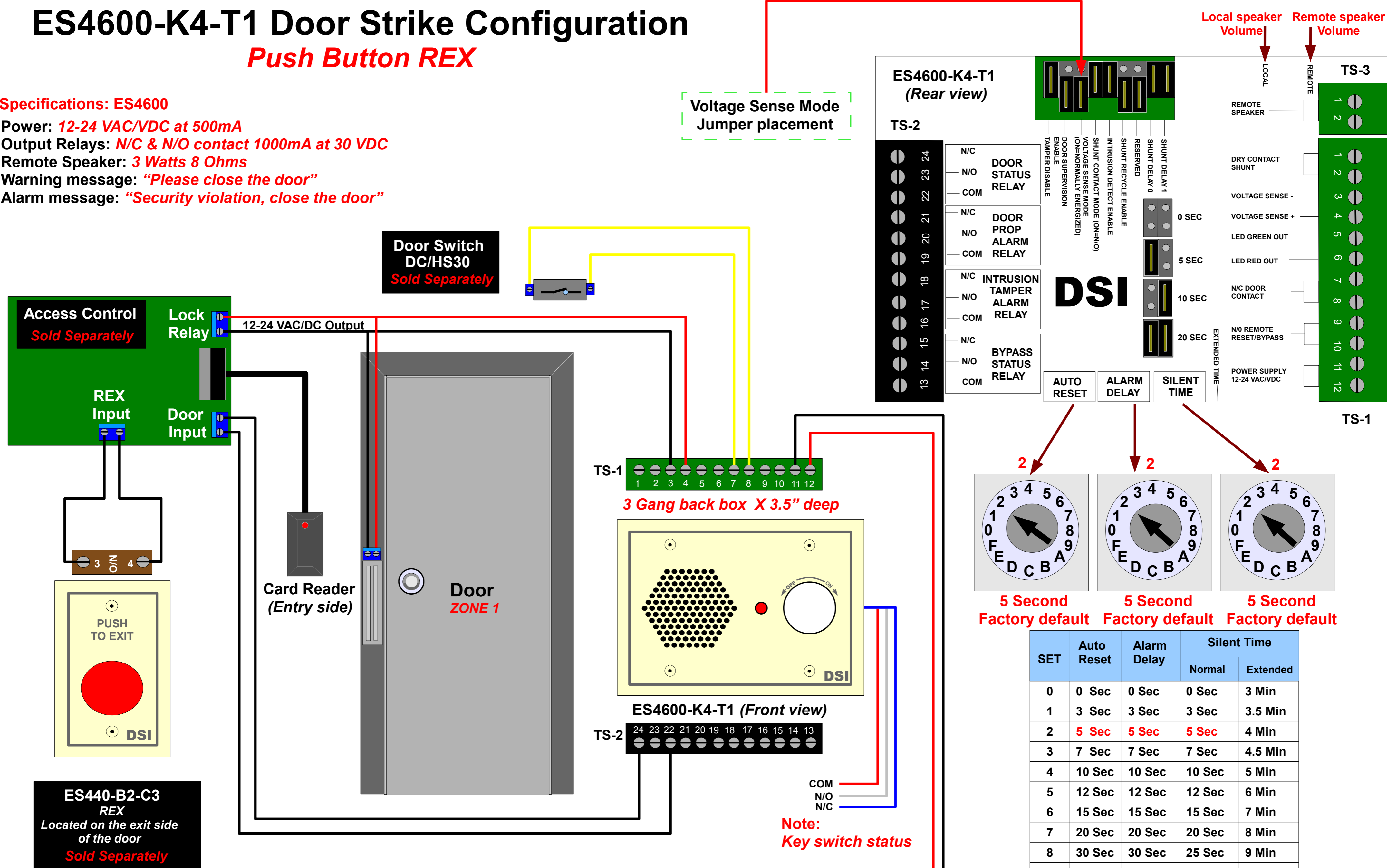

Voltage Sense Mode Jumper placement

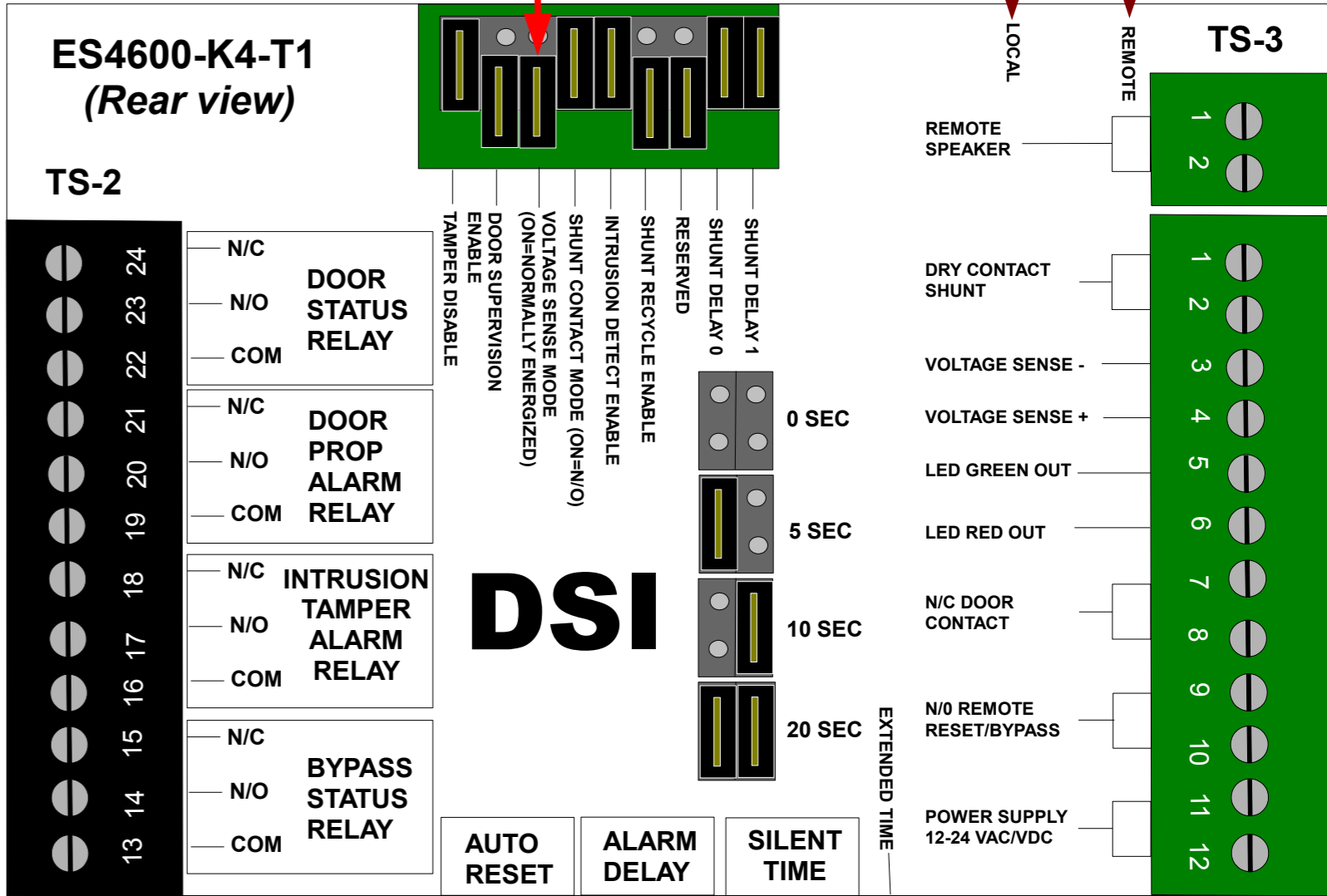

TS-1  
1 2 3 4 5 6 7 8 9 10 11 12  
3 Gang back box X 3.5" deep

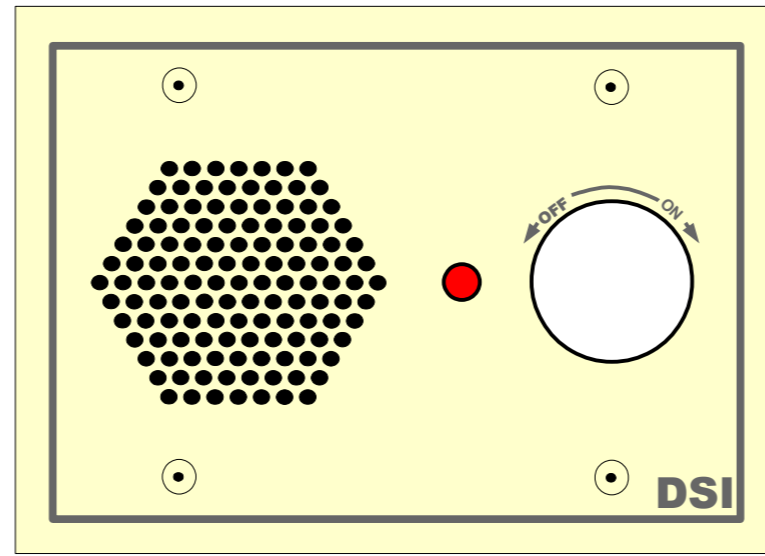

TS-2  
24 23 22 21 20 19 18 17 16 15 14 13

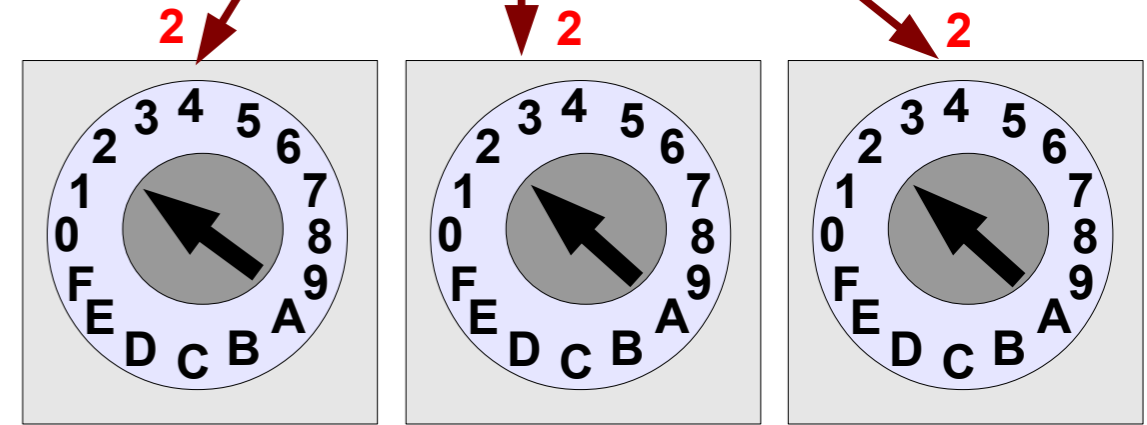

SET	Auto Reset	Alarm Delay	Silent Time	
			Normal	Extended
0	0 Sec	0 Sec	0 Sec	3 Min
1	3 Sec	3 Sec	3 Sec	3.5 Min
2	5 Sec	5 Sec	5 Sec	4 Min
3	7 Sec	7 Sec	7 Sec	4.5 Min
4	10 Sec	10 Sec	10 Sec	5 Min
5	12 Sec	12 Sec	12 Sec	6 Min
6	15 Sec	15 Sec	15 Sec	7 Min
7	20 Sec	20 Sec	20 Sec	8 Min
8	30 Sec	30 Sec	25 Sec	9 Min
9	45 Sec	45 Sec	30 Sec	10 Min
A	1 Min	1 Min	35 Sec	20 Min
B	2 Min	2 Min	45 Sec	30 Min
C	3 Min	3 Min	1 Min	40 Min
D	4 Min	4 Min	1.5 Min	50 Min
E	5 Min	5 Min	2 Min	60 Min
F	Manual	Infinite	2.5 Min	90 Min

Note: Key switch status

12-24 VAC/VDC 500mA Power Supply Sold Separately

Note: Wire Gauge:  
22 AWG = Signal wires  
22 AWG = Power wires  
(Power runs over 50 feet use 18 AWG)

Note: Suggested Power Supply  
PS/DC12  
PS/AC16

ES440-B2-C3 REX Located on the exit side of the door Sold Separately